

# ESENA

# 1D1W

Typ:  
864

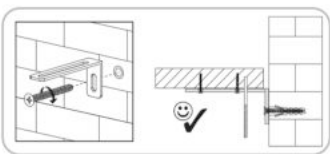
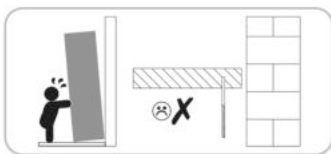
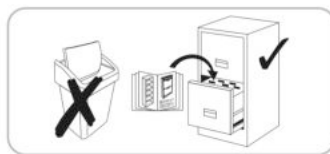
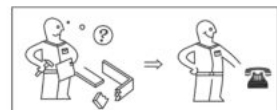
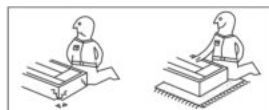
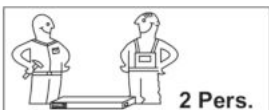

Ø5  
Ø8

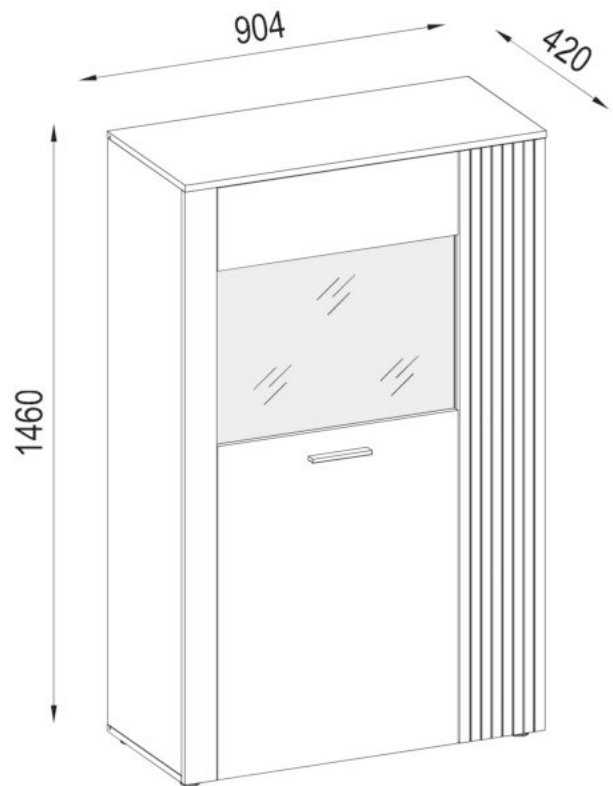
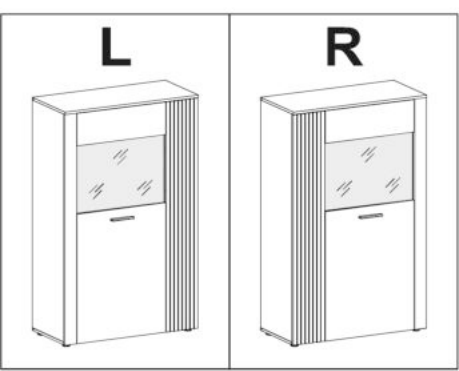

- utáhnout
- stlačit
- změřit
- stisknout
- zatlouct
- otočit - obrátit

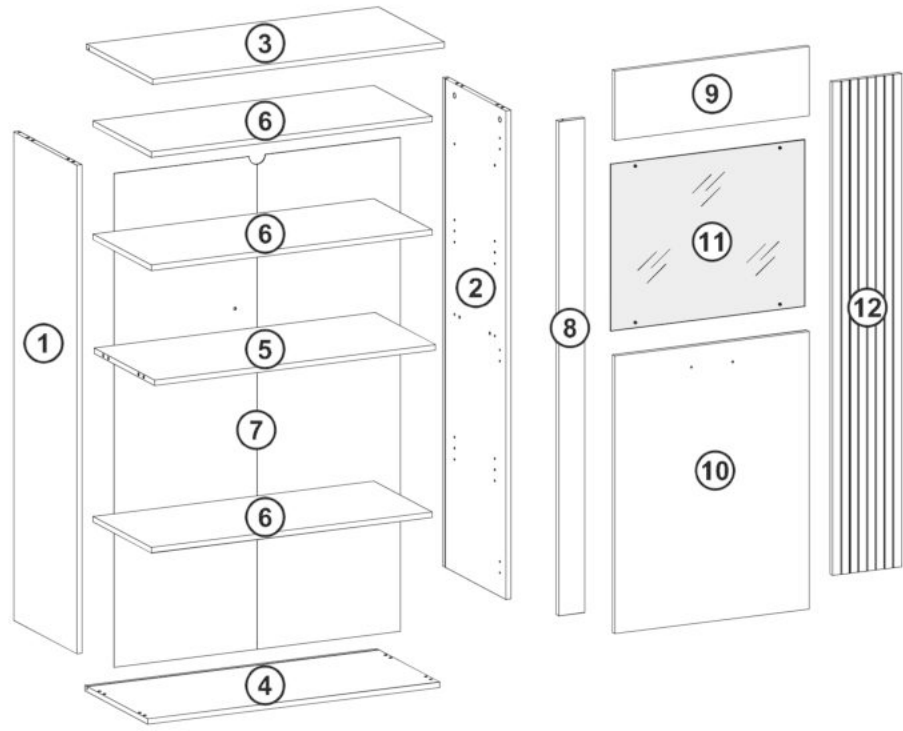

max. 10KG = 4      max. 5KG = 5 6

A	B (mm)		C	D
1	1408	400 16	x1	2/2
2	1408	400 16	x1	2/2
3	904	420 16	x1	1/2
4	904	400 16	x1	1/2
5	870	384 16	x1	1/2
6	870	370 16	x3	1/2
7	1423	886 2,5	x1	2/2

A	B (mm)		C	D
8	1424	80 18	x1	2/2
9	200	604 16	x1	2/2
10	800	604 16	x1	2/2
11	602	481 4	x1	2/2
12	1421	214 16	x1	2/2

B1				1/2
----	--	--	--	-----



## B1 1/2

<b>A1</b> 15x12 x8		<b>C2</b> 44mm x8		<b>B2</b> 8x30 x12	
<b>FA1</b> 4mm x1		<b>F3</b> 6,3x50 x4		<b>O3</b> Ø18 x4	
<b>K6</b> Ø35 x3		<b>J65</b> 128/148 x1		<b>O4</b> Ø18 x4	
<b>M1</b> 10x10x15 x12		<b>P14</b> 45x20 x4		<b>N1</b> Ø6 x12	
<b>Y36</b> 75x32x15 x1		<b>N5</b> 10x6x10 x4		<b>DB2</b> 4x25 x2	
<b>D25</b> 4x25 x4		<b>Y37</b> 8x50 x1		<b>Y35</b> 4,2x65 x1	
<b>DA21</b> 4,2x16 x18		<b>D11</b> 3,5x16 x14		<b>R10</b> Ø10 x4	
<b>T1</b> 30x35x55 x3		<b>K9</b> Ø35 x3		<b>O5</b> Ø8 x2	
<b>O6</b> 40x40x14 x3					

Náš nábytek se musí používat podle předpisů. Používání v rozporu s předpisy může vést k věcným škodám a za jistých okolností také k zraněním osob. Nábytek není hračka. Za škody, které vzniknou používáním proti předpisům nebo nesprávnou manipulací, nepřijímá výrobce nebo prodejce žádnou zodpovědnost.

**POZOR:** Děti nebo osoby s mentálním postižením se musí neustále držet mimo dílů nábytku, špičatých předmětů, drobných částí a obalových materiálů, protože hrozí riziko zranění a/nebo udušení.

**MONTÁŽ:** Při montáži dodržujte náš návod k používání, obsluze, instalaci nebo montáži a dávejte hlavně pozor na výstražné a bezpečnostní pokyny. Pokud se nebudou dodržovat předpisy, může to mít za následek zranění osob nebo poškození nábytku / ohrožení bezpečnosti. Pokud byste měli potíže s instalací/montáží, kontaktujte náš servisní tým. Tento vám ochotně poradí a pomůže. Montáž smí provádět pouze kvalifikovaný personál. Při změnách na produktu/dílechproduktu, při výměně nebo použití dílů/spotřebních materiálů, které nepocházejí od výrobce/prodejce, nepřijímáme žádnou odpovědnost za škody.

Pokud jsou ke zboží přiloženy upevňovací prvky na zeď, jako jsou hmoždinky a šrouby, jsou tyto určeny výhradně pro použití na stěnách z pevných a jedolitých materiálů. Upevnění je jen tak dobré, jak dobré je spojení mezi upevňovacím prostředkem a stěnou. Před upevněním musíte zkontrolovat vhodnost vaší stěny pro stojící i závěsný nábytek a použít pouze vhodné spojovací prvky. Před případným vrtáním se ujistěte, že se v oblasti vrtání nenachází elektrické vodiče. Nakonec je za upevnění na stěnu odpovědný instalační technik.

Platí to také pro instalaci elektrických produktů a dalšího stavebně-technického příslušenství. Montáž/instalaci elektrických produktů a také dalšího důležitého konstrukčního příslušenství může provádět pouze autorizovaný kvalifikovaný personál. Veškeré elektrické a stavebně-technické instalace musí být provedeny v souladu s platnými normami a bezpečnostními předpisy ve vaší zemi. Pro světelné zdroje používejte pouze povolenou intenzitu osvětlení. Při nedodržení max. počtu Watt hrozí riziko požáru v důsledku přehřátí. Překrývání svítidel není povoleno z důvodu rizika požáru.

Dokonale funkce nábytku je zaručena pouze při vertikální a horizontální instalaci. Dveře jsou předem nastavené, mohou se ale znovu seřadit/nastavit na základě místních podmínek. Dodržujte údaje o hmotnostní pro maximální zatížení. Na nábytek se nesmí lézt. Při neodborném použití může dojít k převrácení nábytku. Aby se tomu zamezilo, musí být nábytek neustále zajištěn proti převrácení. Při přetížení/nadměrném přetížení (zejména hrajkami si dětmi, lidmi, materiálem nebo jinými nevhodnými vlivy) hrozí riziko rozbití a zranění. Všechny šrouby a nosná spojovací místa by měla být dotazena po 5 až 6 týdnech, aby se zajistila trvalá stabilita.

### PÉČE:

-Pokyny k péči o nábytek-

Dodržujte naše pokyny pro správnou péči o nábytek, abyste si náš výrobek mohli užívat co nejdéle. Při čištění používejte čistý, suchý a měkký bavlněný hadřík. Pokud potřebuje váš nábytek důkladné vyčištění, můžete hadřík navlhčit trochou vody nebo čisticího prostředku na nábytek a pak vyčištěné věci vysušit. Kovové a skleněné díly se nejlépe čistí běžně dostupnými čisticími prostředky na kovy a sklo podle pokynů, které jsou na nich uvedené. Na čisticích prostředcích musí být jasně uvedeno, že jsou vhodné k čištění nábytku.

V žádném případě nepoužívejte parní čističe, žíraviny, abraziva nebo jiné prostředky, jejichž účinky neznáte. **POZOR:** Vysoce lesklé povrchy jsou při dodávce chráněny ochrannou fólií. Nechte fólii na nábytku, dokud nebude zcela smontován a zbaven prachu. Vysoce lesklé prvky, ze kterých byla odstraněna ochranná fólie, lze čistit a používat až po 72 hodinách (doba pro následné vytvrzení na okolním vzduchu). Povrchy nelze poškodit ostrými předměty a nikdy je nemůžete vystavovat silnému slunečnímu záření.

### LIKVIDACE



-Pokyny k likvidaci odpadu-

V zájmu ochrany životního prostředí vyhazujte obalový odpad rozříděný podle druhu do určených odpadkových/recyklačních nádob, v žádném případě nevyhazujte do přírody. Poškozený nebo nepoužitelný nábytek lze odeslat do speciálních sběrných zařízení k recyklaci jednotlivých dílů. Používaný, ale stále funkční nábytek není nutné hned likvidovat. Darujte je např. charitativním organizacím.

Přejeme vám mnoho zábavy s vašim novým nábytkem.

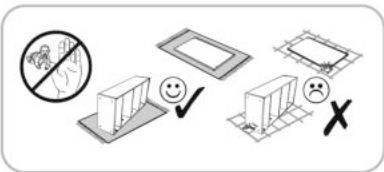
# 1



- A1** 15x12  x4
- C2** 44mm  x4
- B2** 8x30  x8

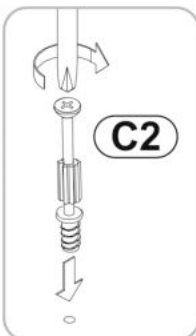
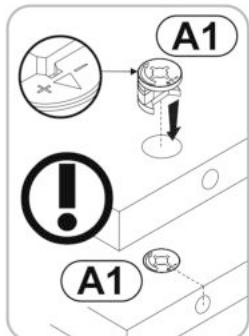
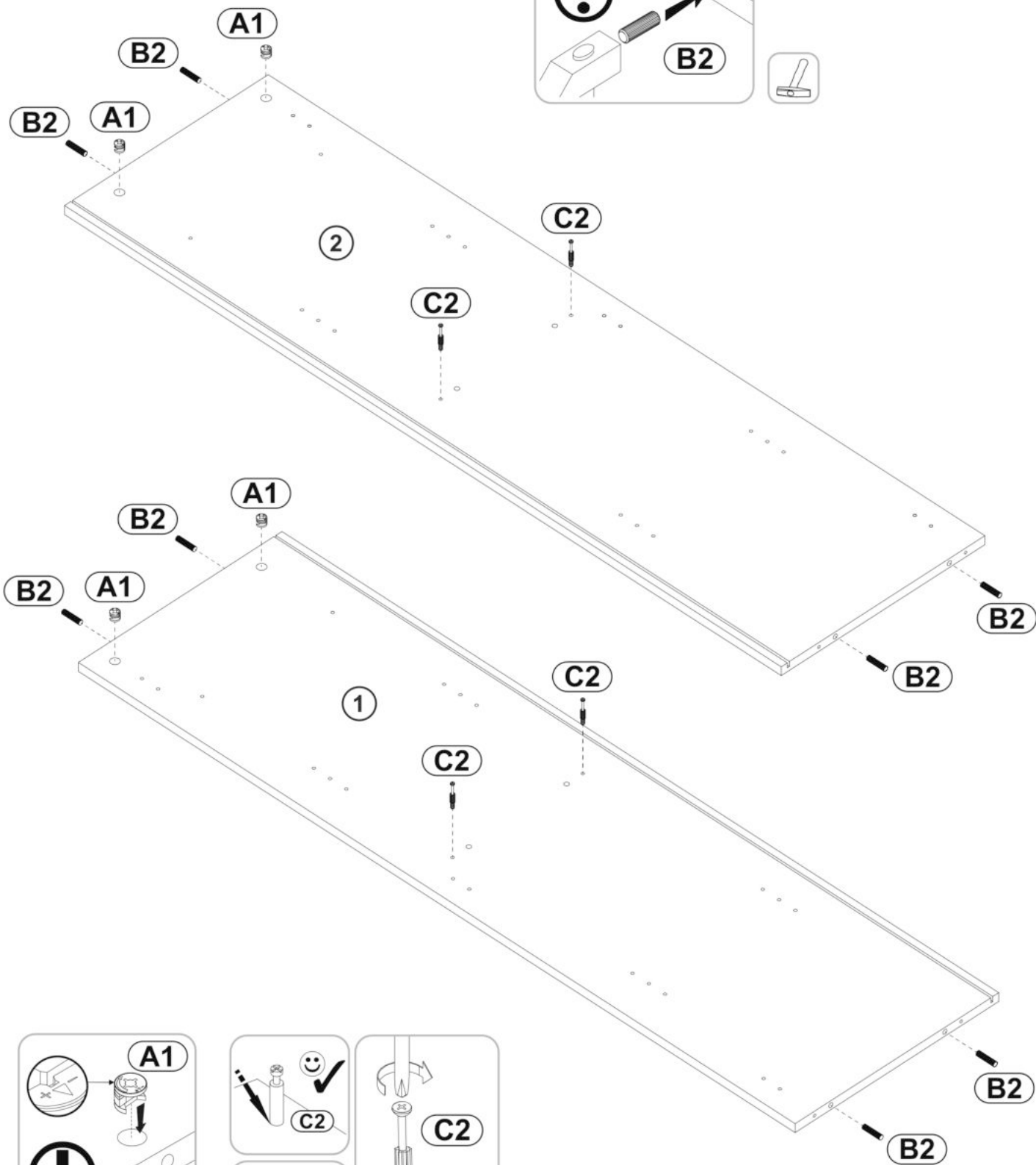
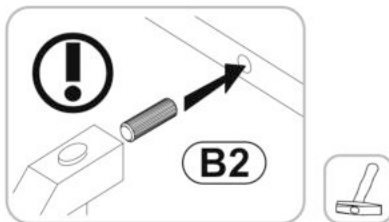

# 2

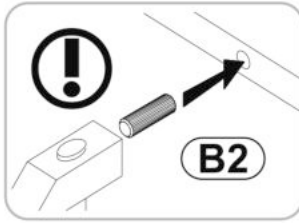
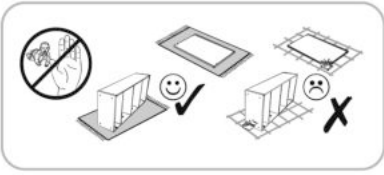

<b>A1</b>		x4
<b>C2</b>		x4
<b>B2</b>		x4
<b>Y36</b>		x1
<b>D11</b>		x2

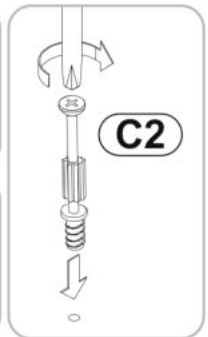
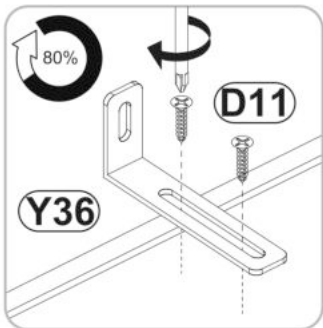
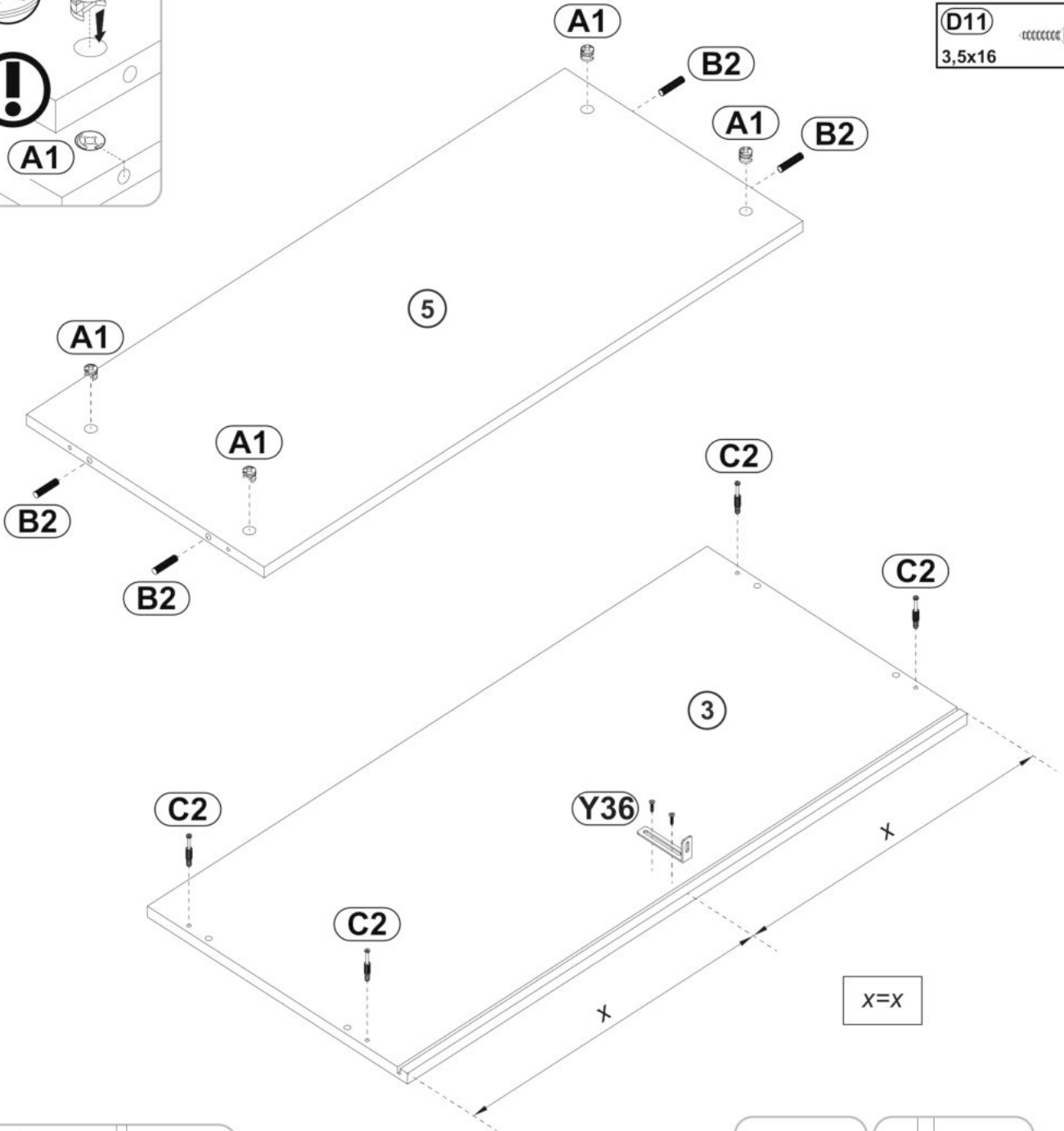
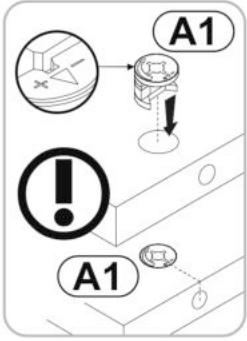

# 3

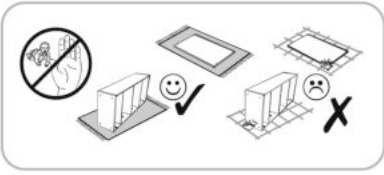

**DA21**  
4,2x16  x6

**T1**  
30x35x55  x3

**K9**  
Ø35  x3

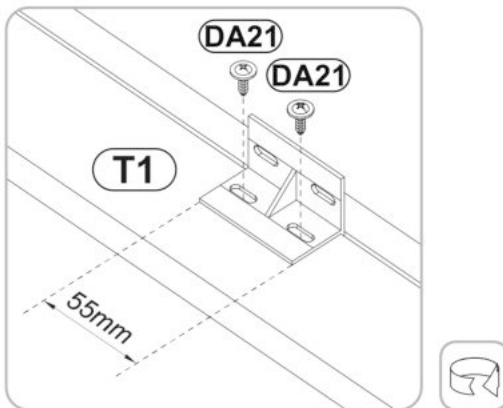
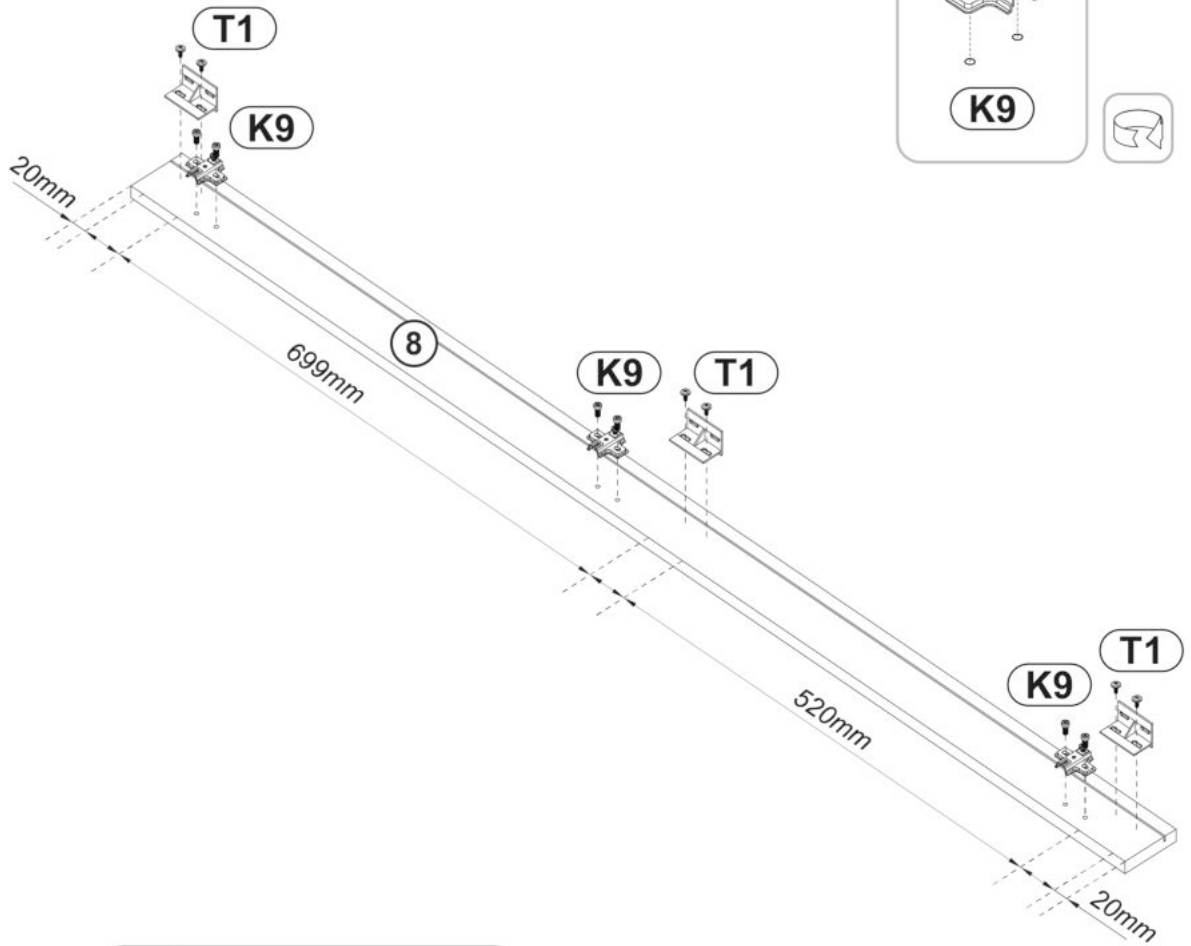
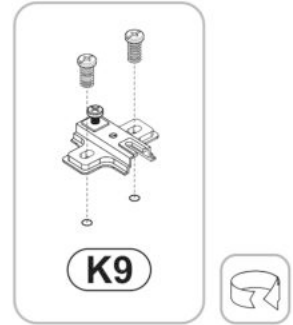
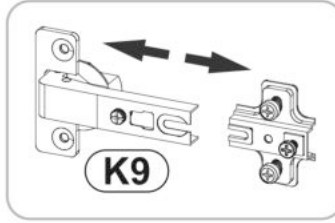

# 4

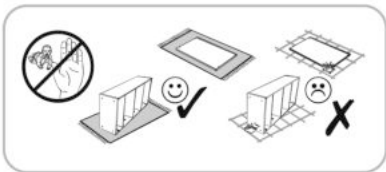

**O3**  **x4**  
Ø18

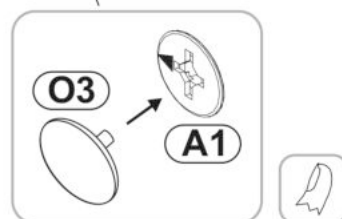
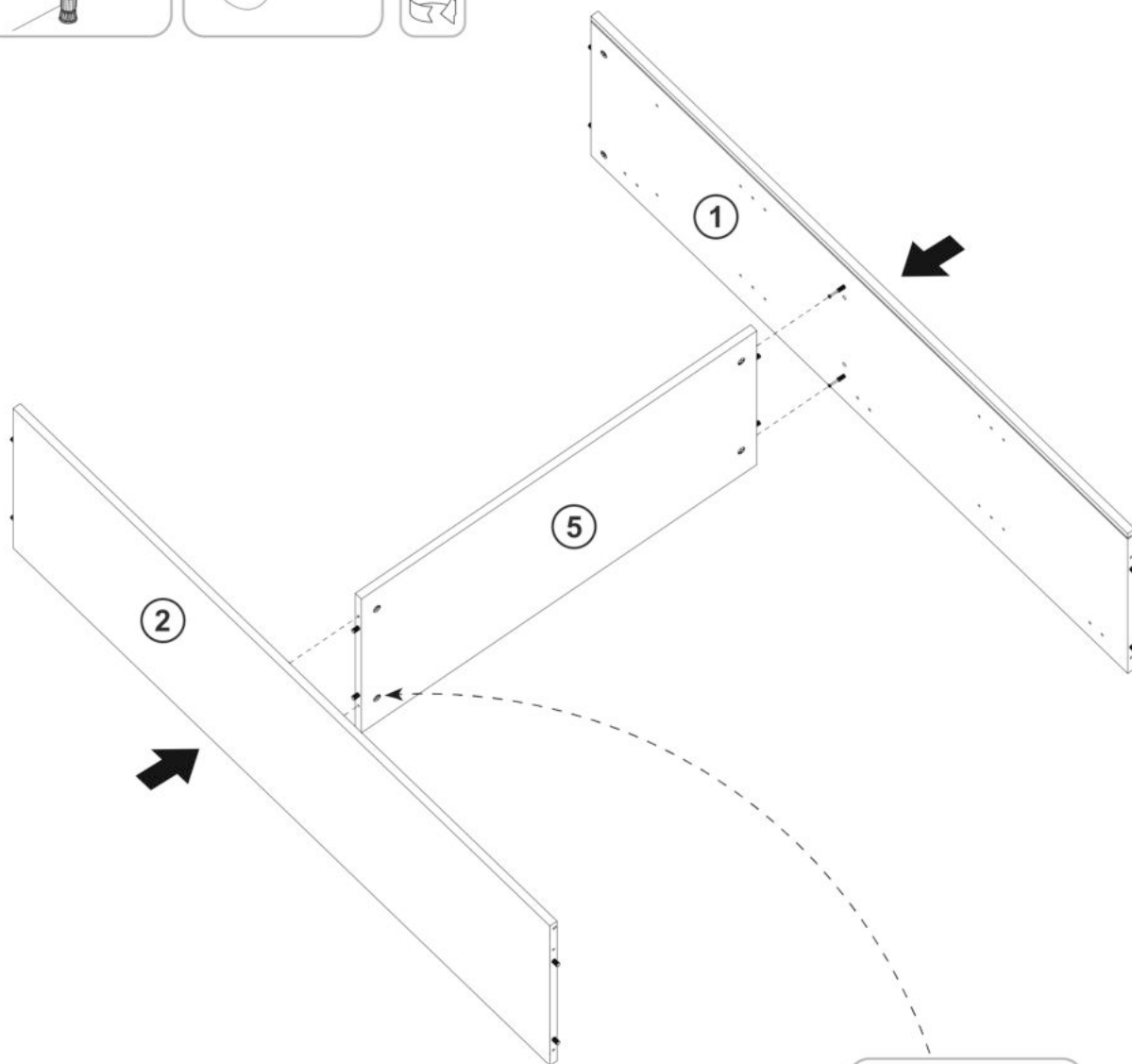
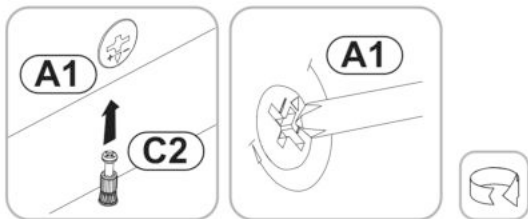

# 5

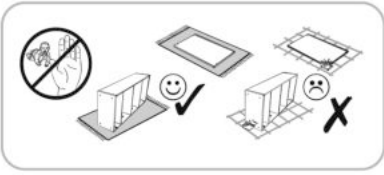

**O4**  **x4**  
Ø18

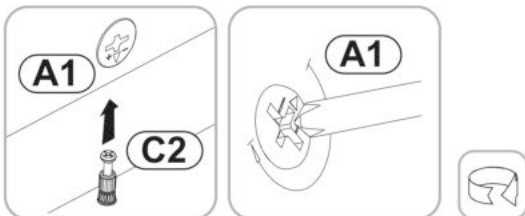
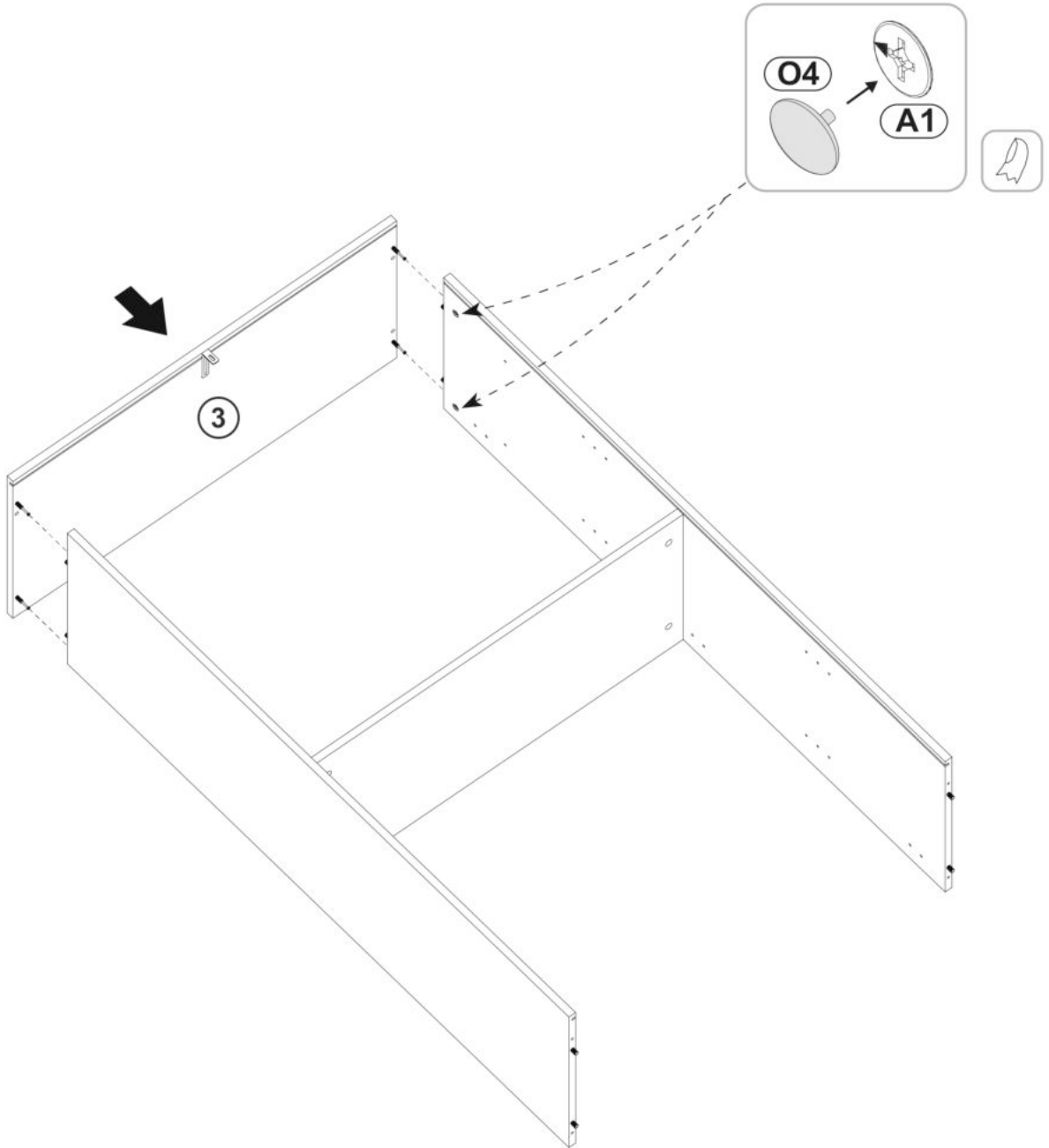

6

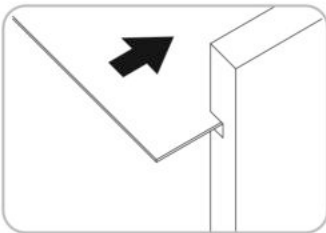
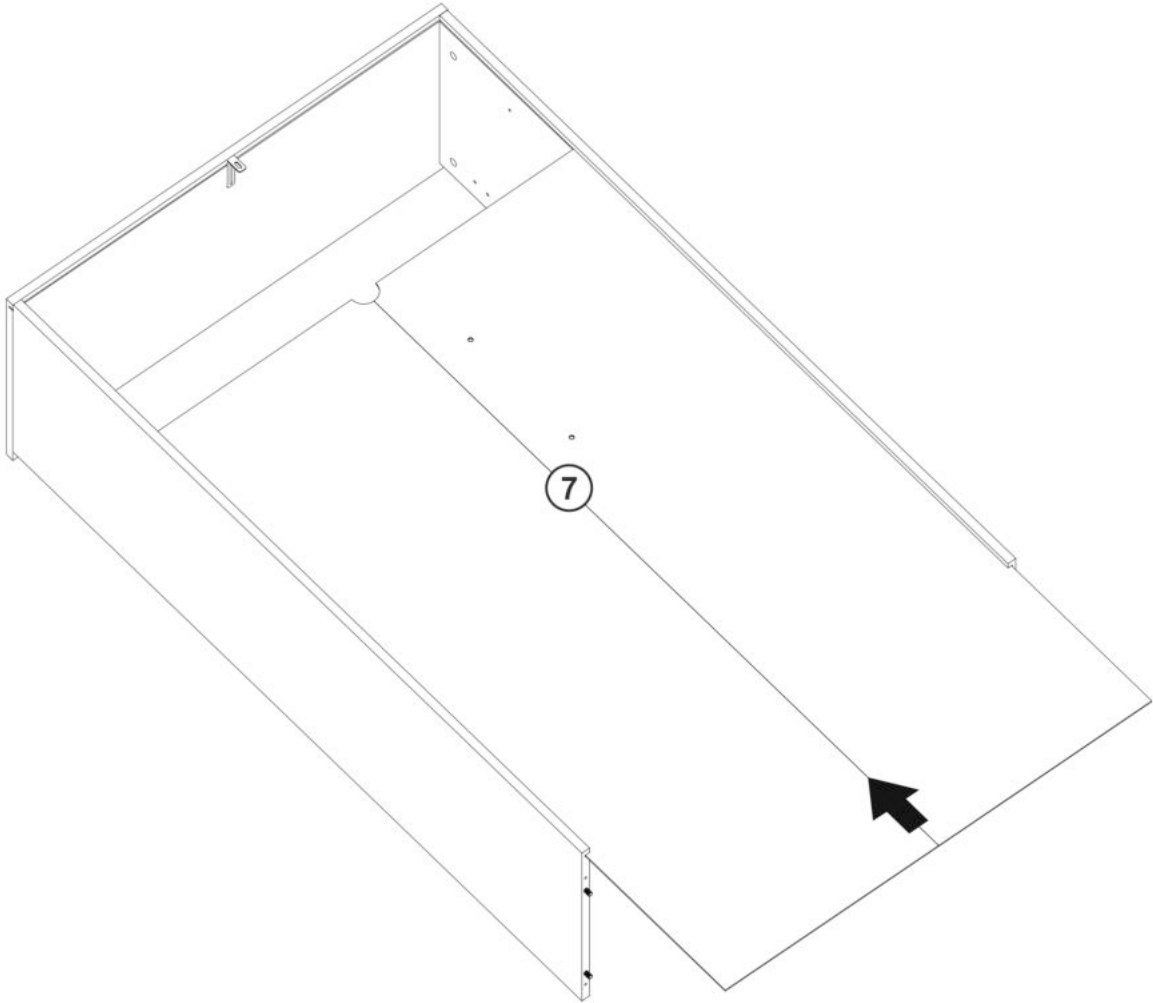
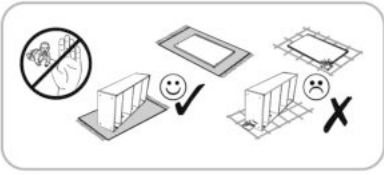



7

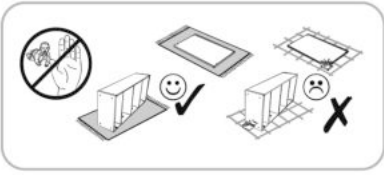

**FA1**  
4mm x1

**F3**  
6,3x50 x4

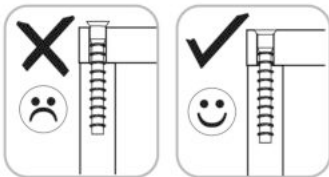
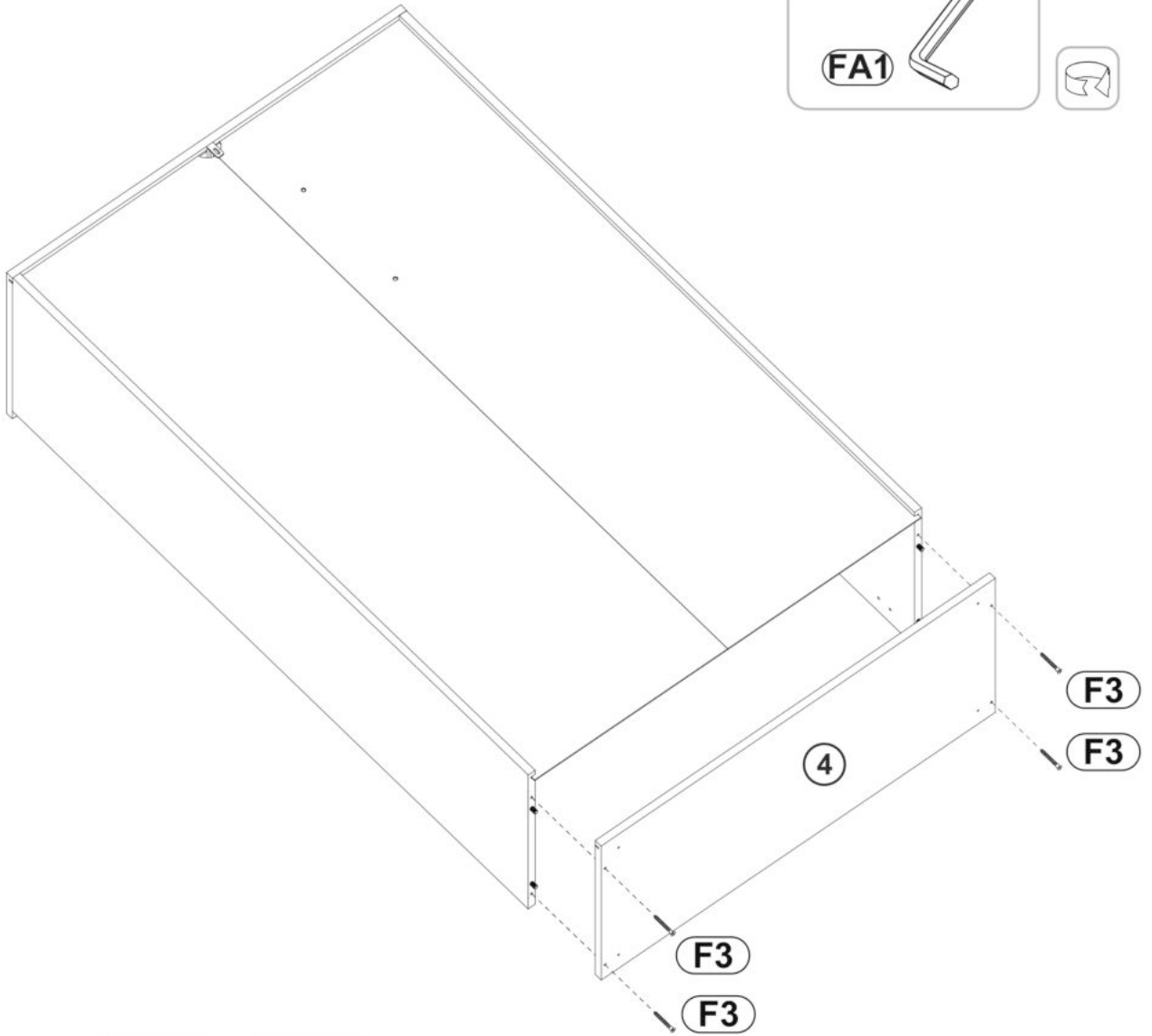
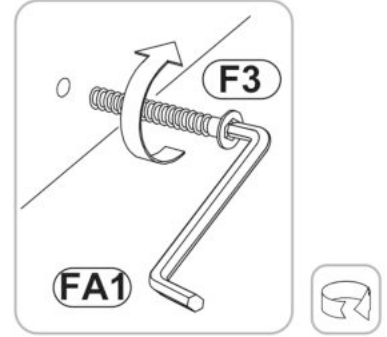

# 8

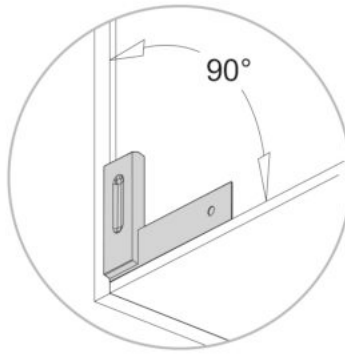
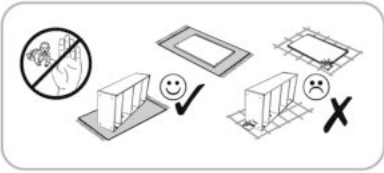

A=B

**M1**  
10x10x15 x12

**DA21**  
4,2x16 x2

**P14**  
45x20 x4

**D25**  
4x25 x4

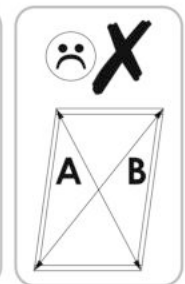
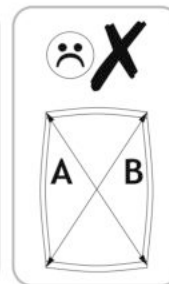
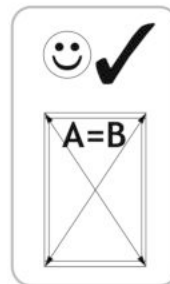
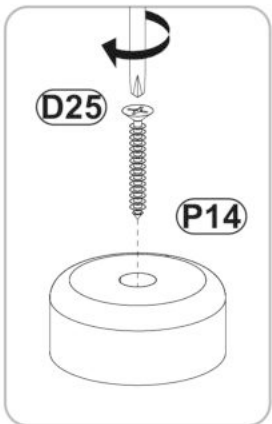
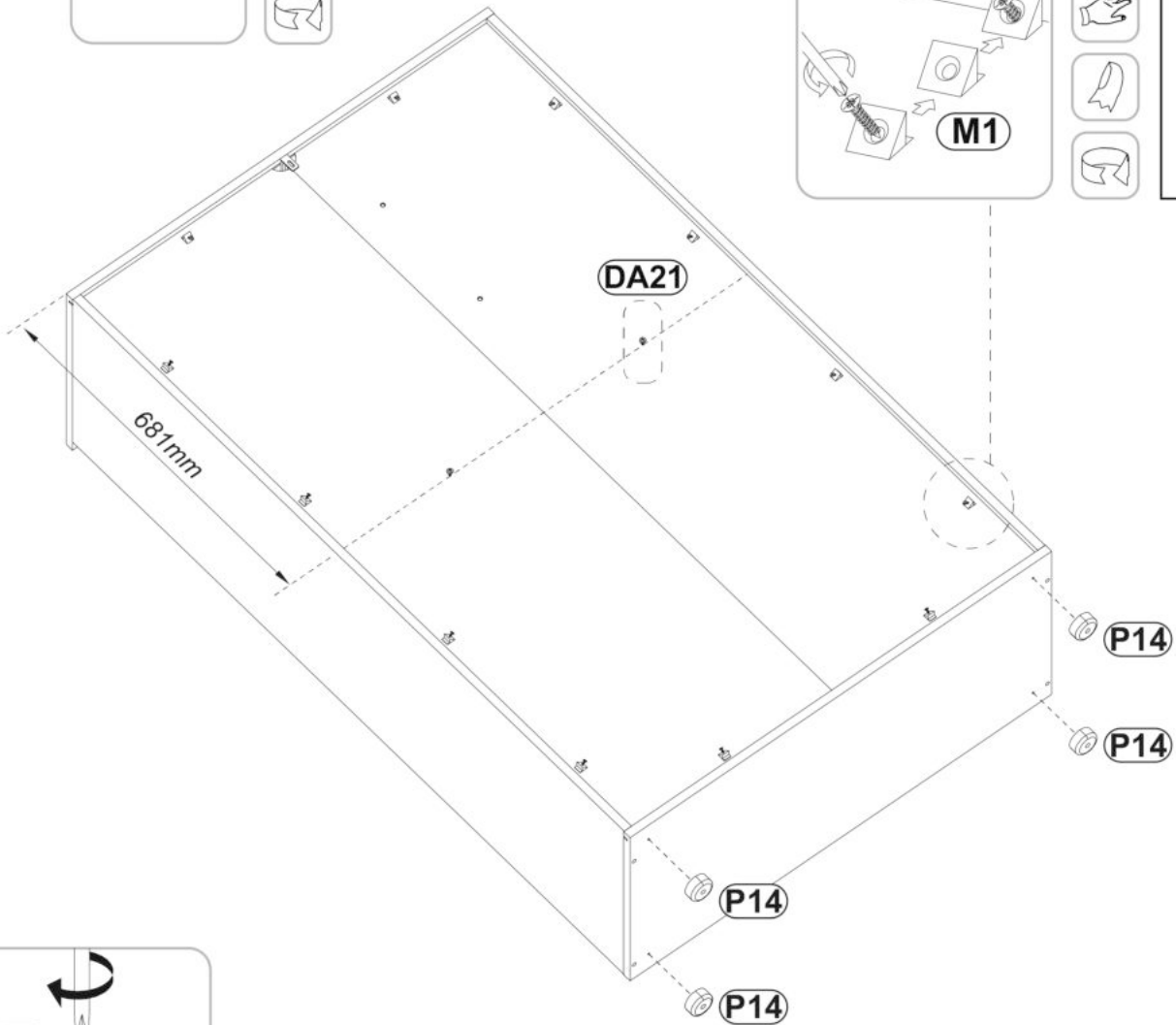
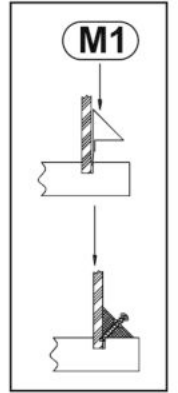
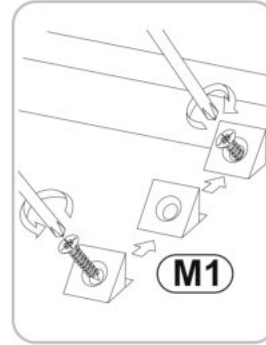
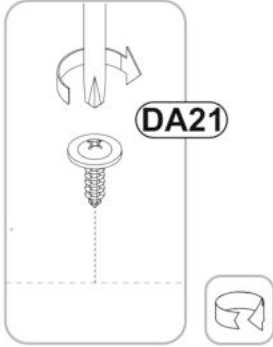

9

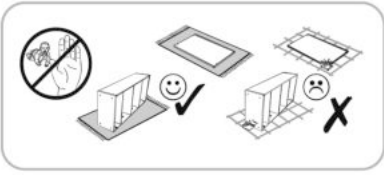

**N1**  **x12**  
Ø6

**O5**  **x2**  
Ø8

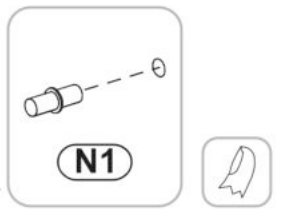
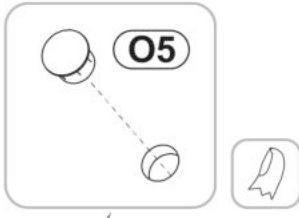
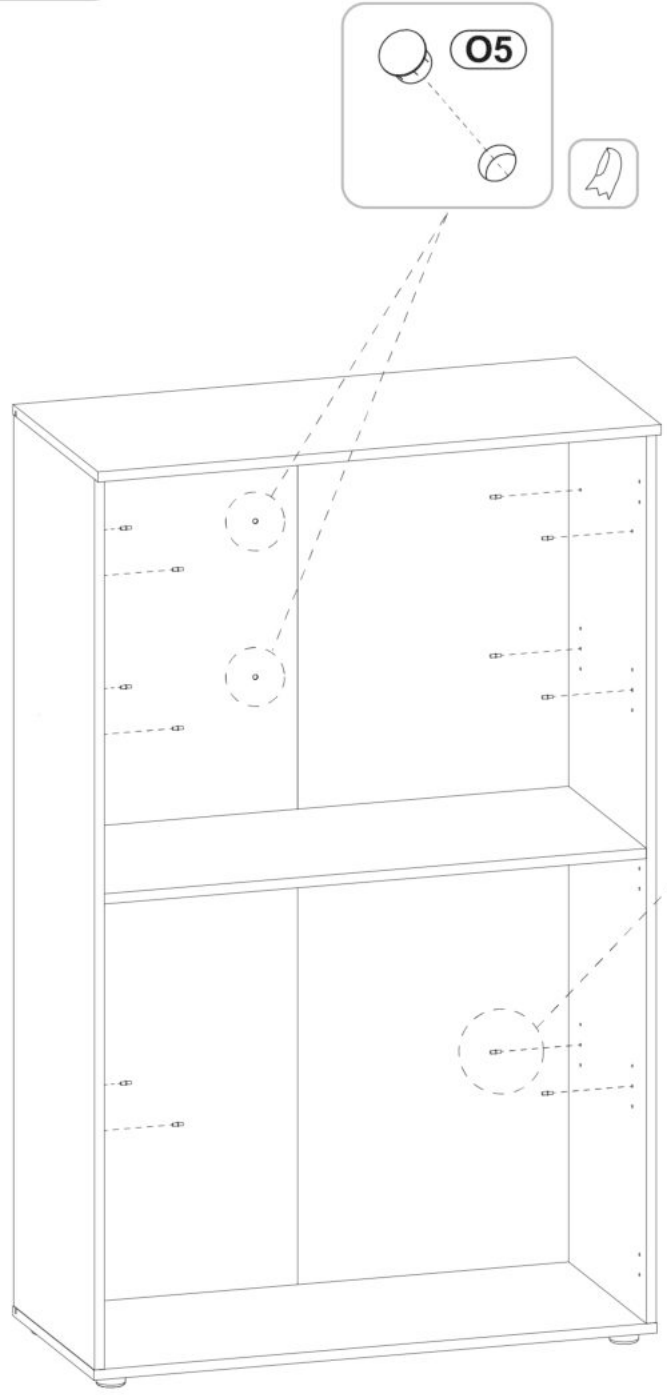

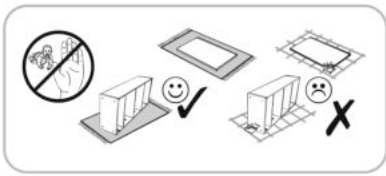

- Y37**  
8x50 x1
- Y35**  
4,2x65 x1

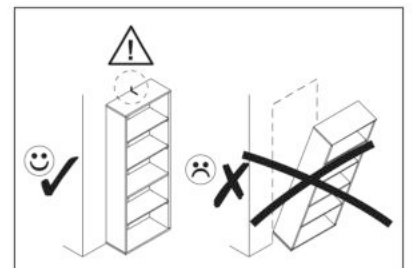
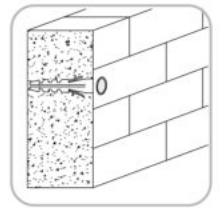
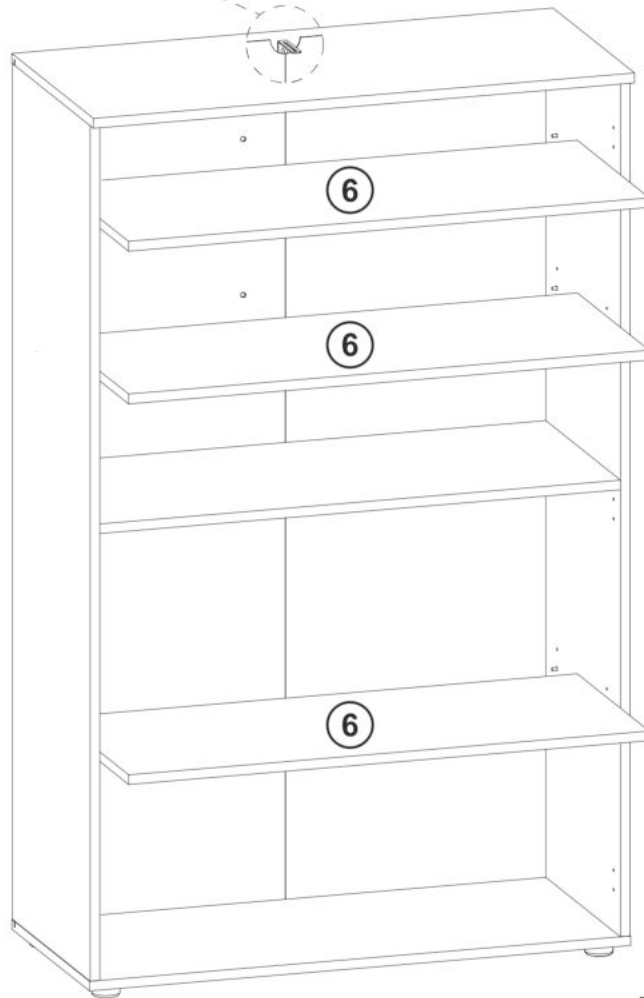
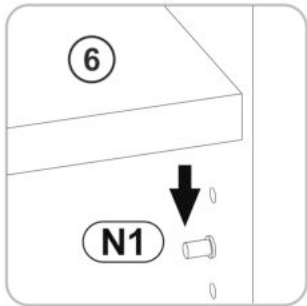
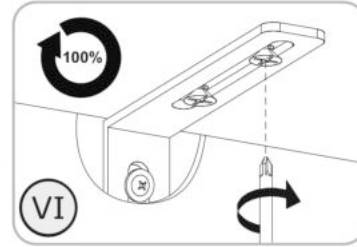
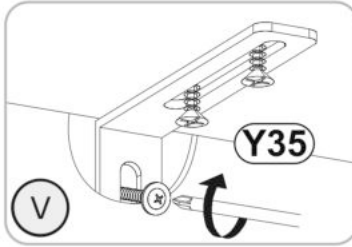
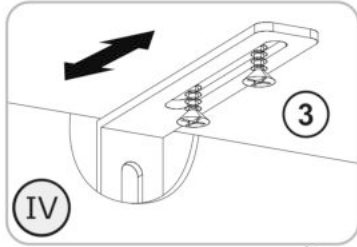
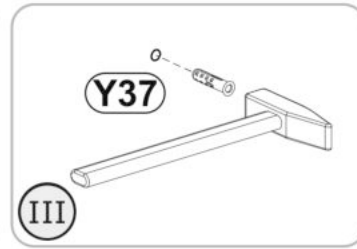
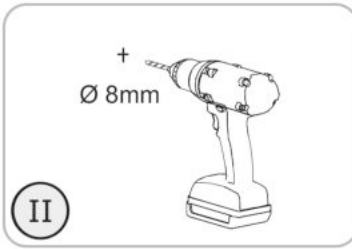
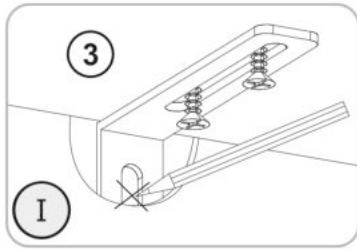

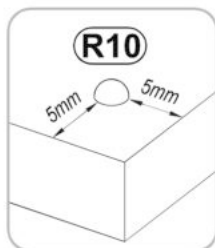
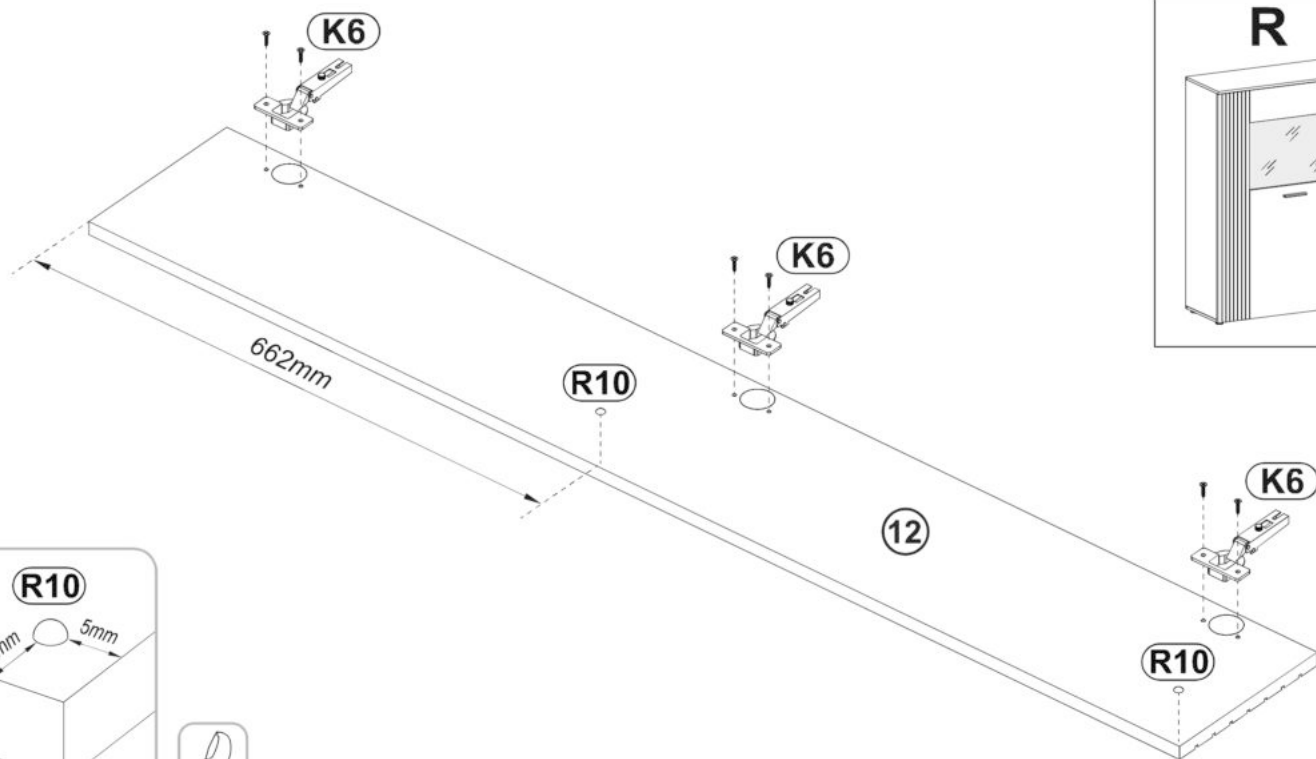
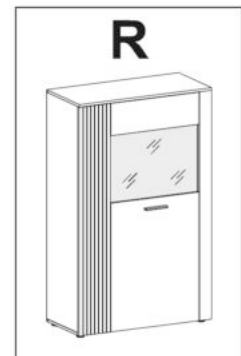
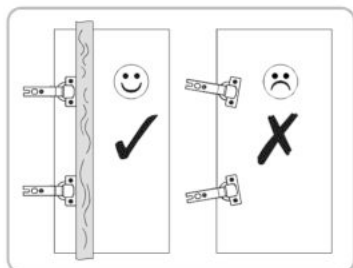
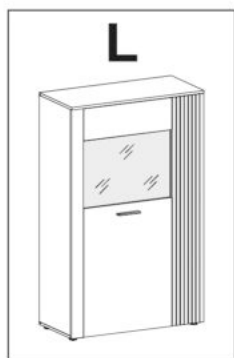
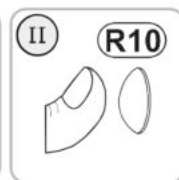
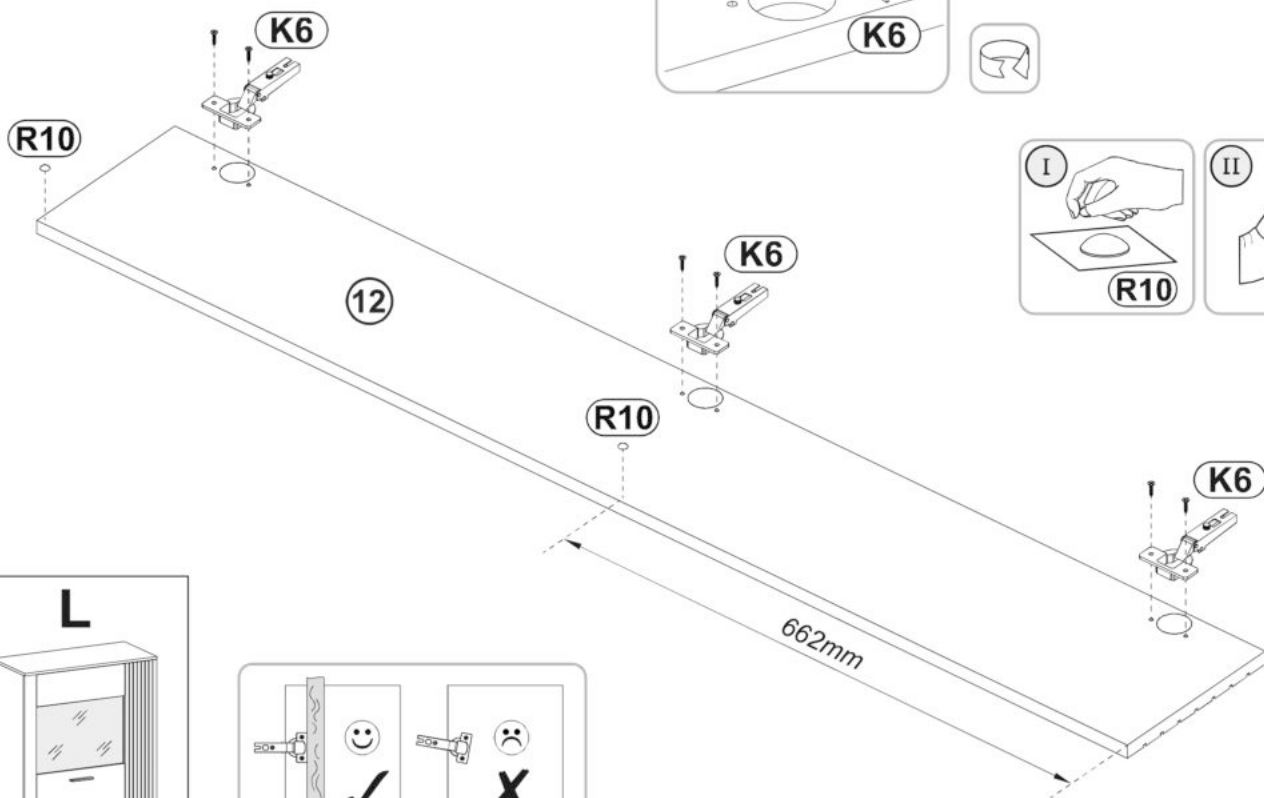
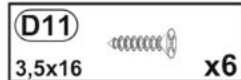
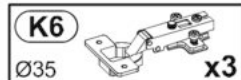
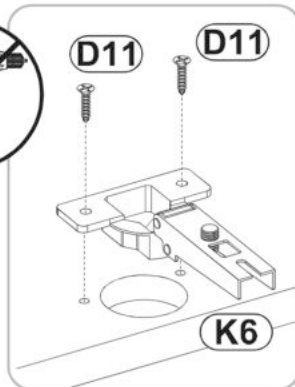
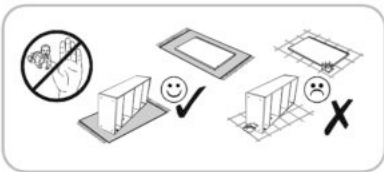

# 12

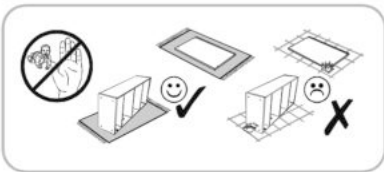

<b>(N5)</b> 10x6x10		<b>x4</b>
<b>(DA21)</b> 4,2x16		<b>x4</b>
<b>(R10)</b> Ø10		<b>x2</b>
<b>(DB2)</b> 4x25		<b>x2</b>
<b>(J65)</b> 128/148		<b>x1</b>

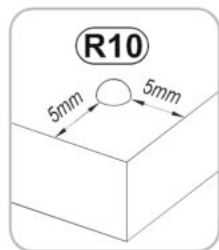
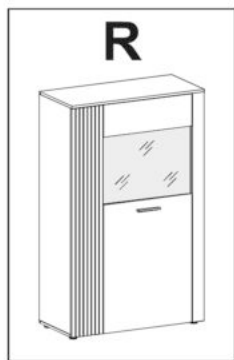
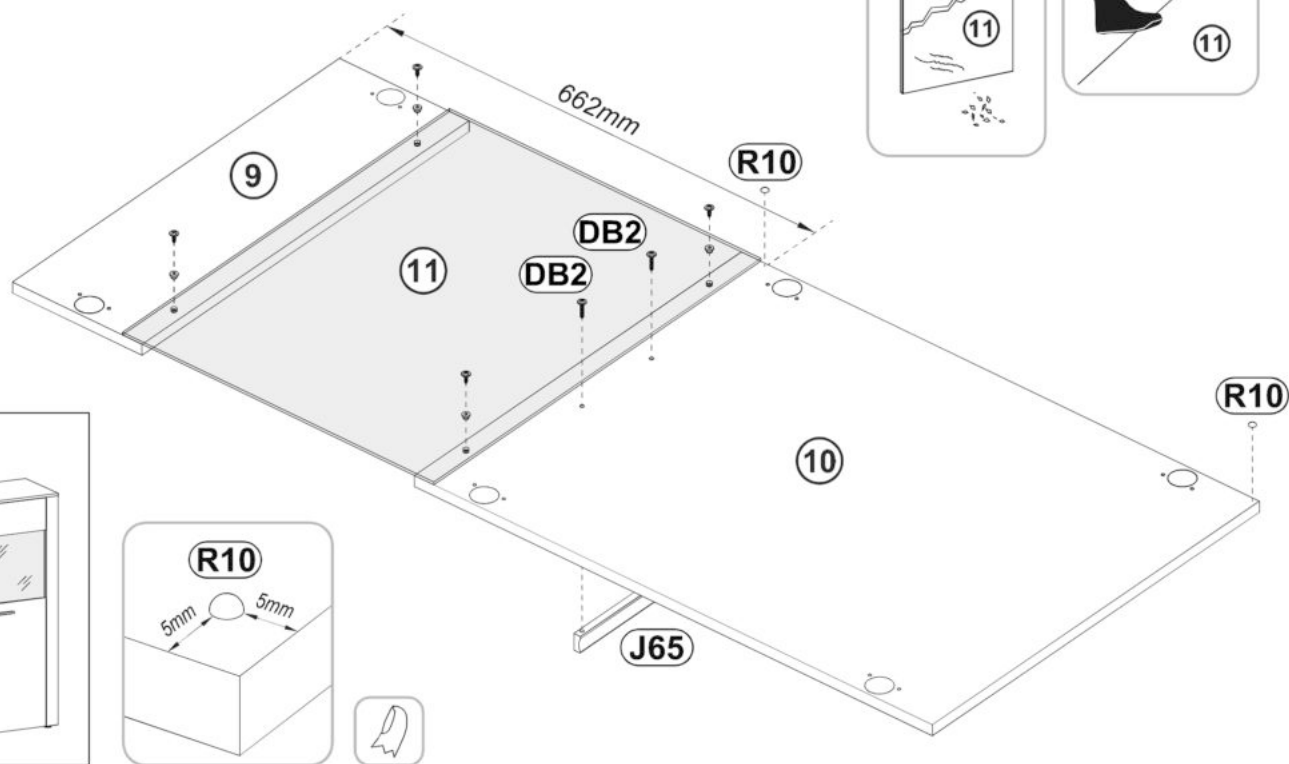
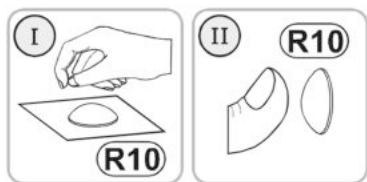
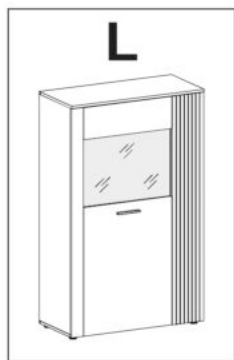
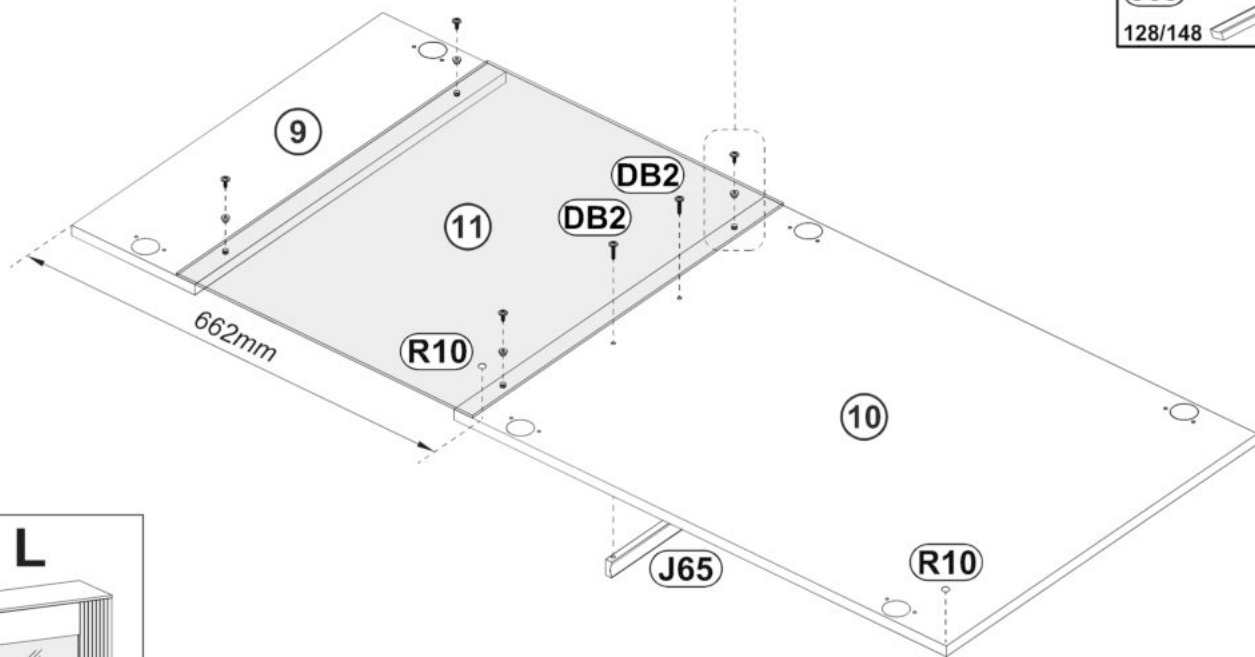

# 13

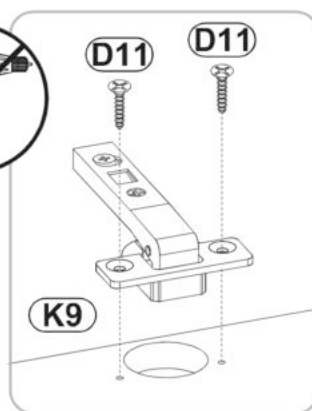
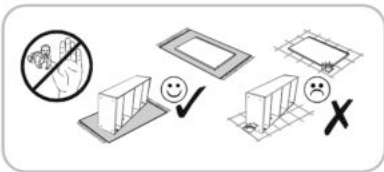

**K9**  x3  
Ø35

**D11**  x6  
3,5x16

**O6**  x3  
40x40x14

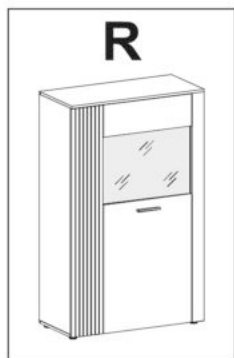
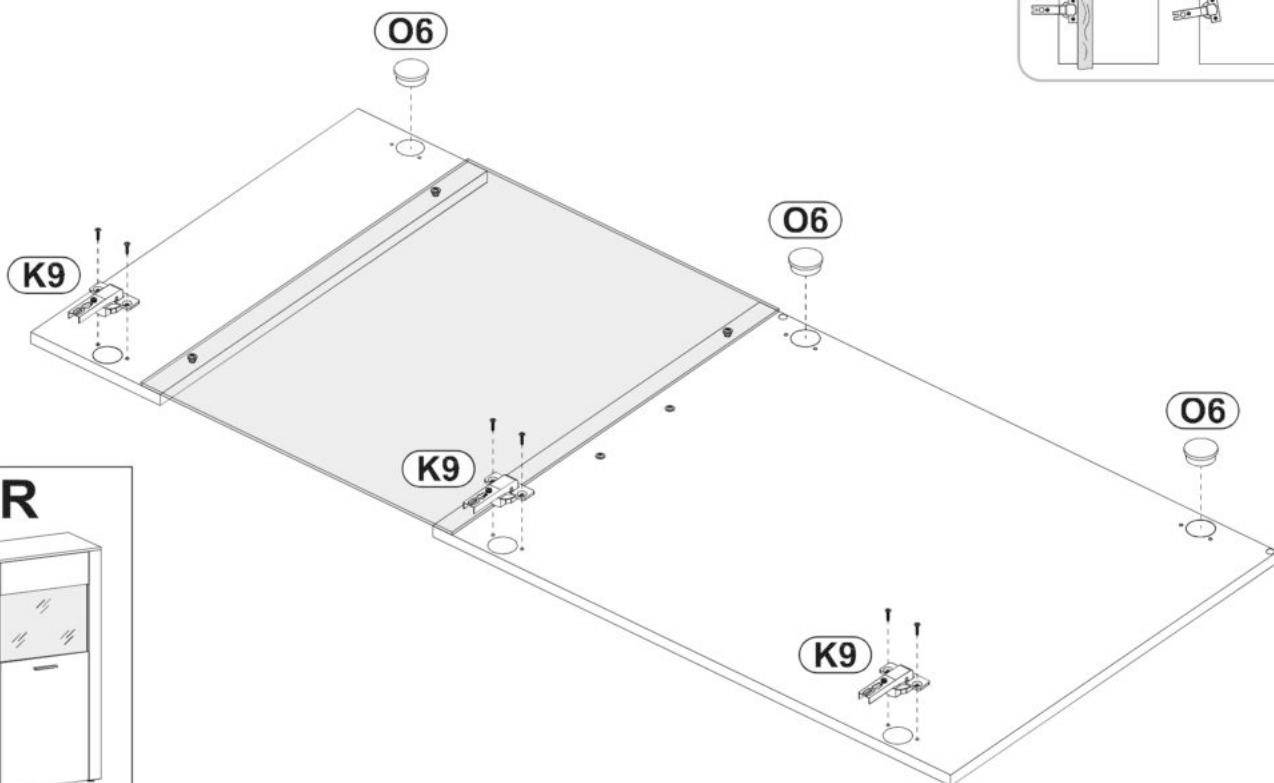
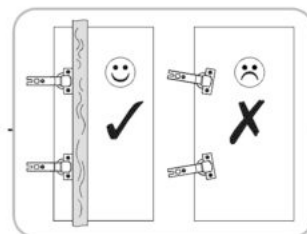
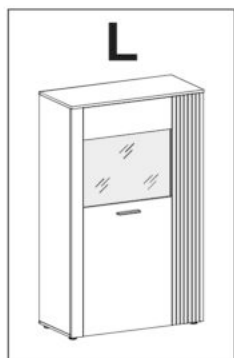
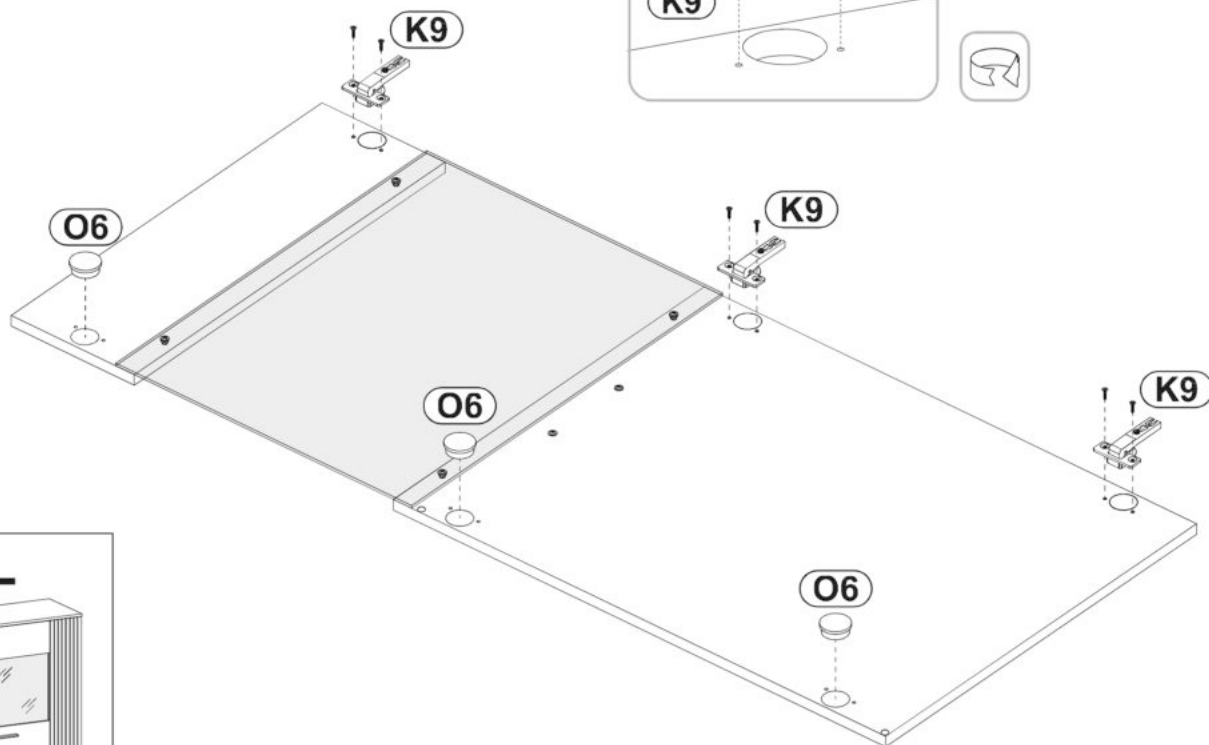

# 14

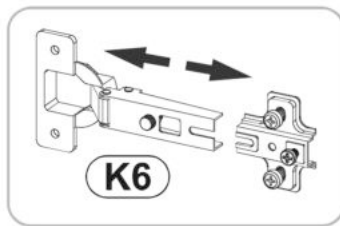
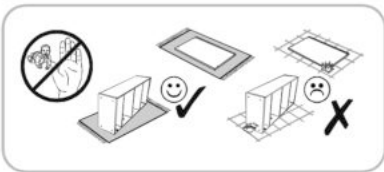

**K6**  
Ø35  x3

**DA21**  
4,2x16  x6

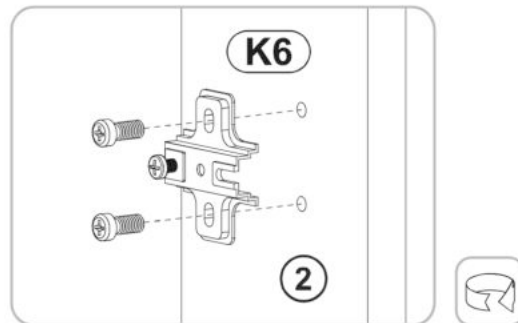
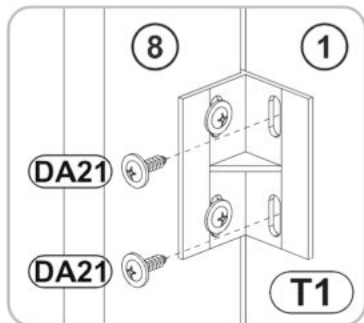
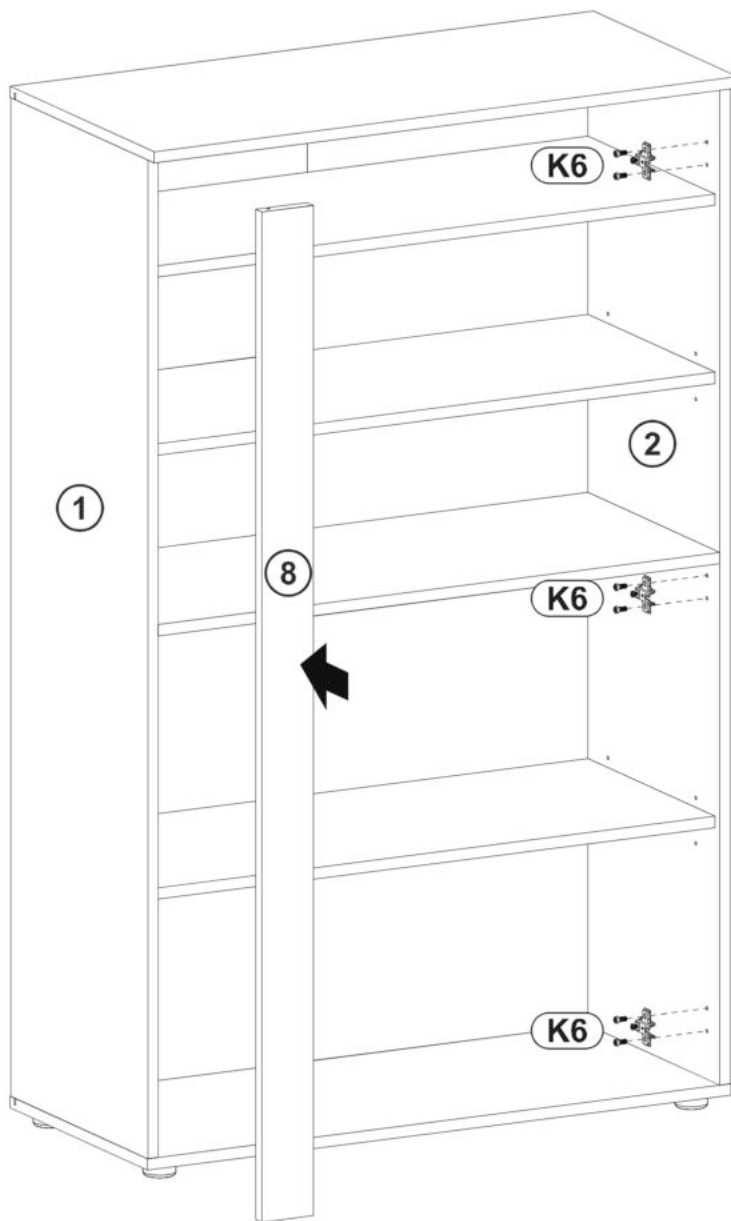
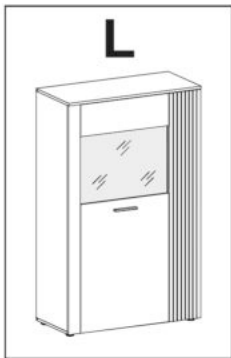



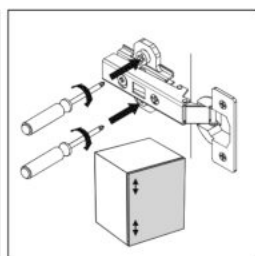
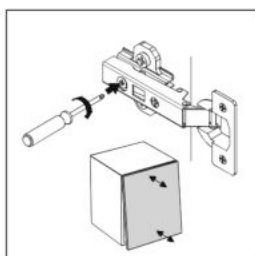
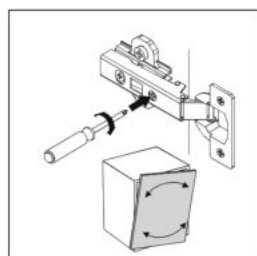
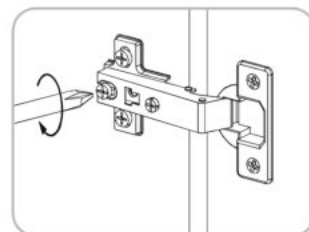
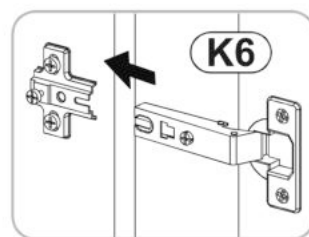
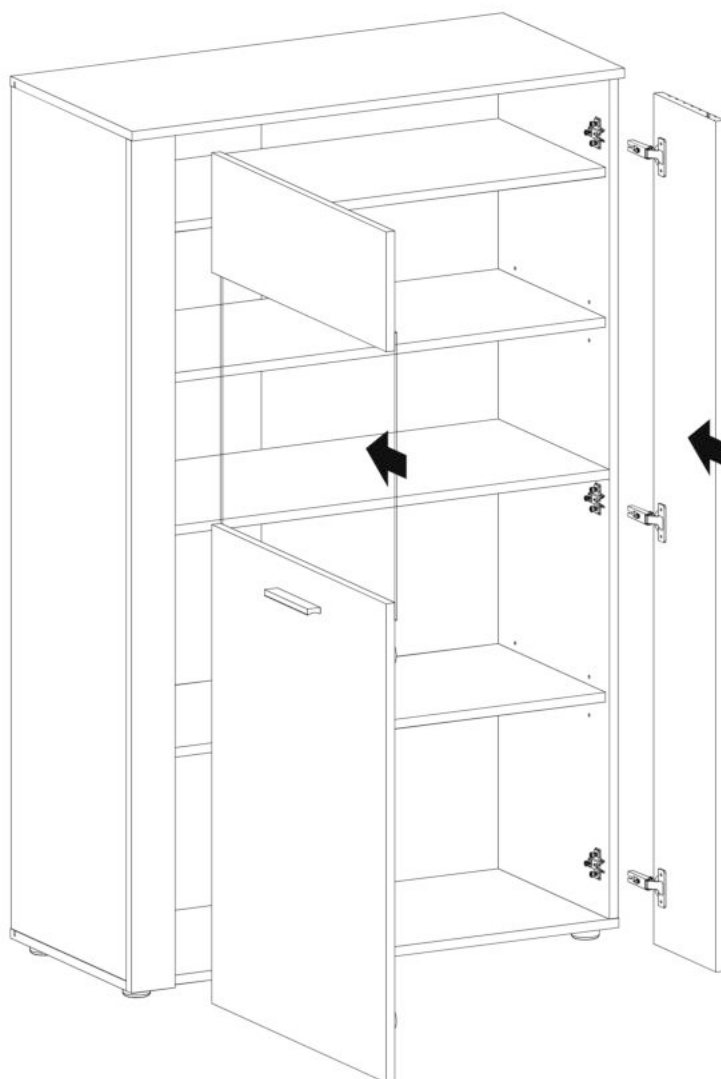
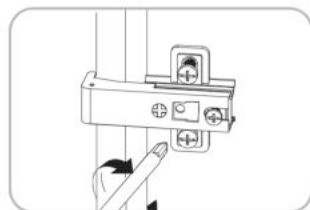
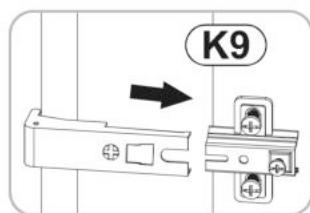
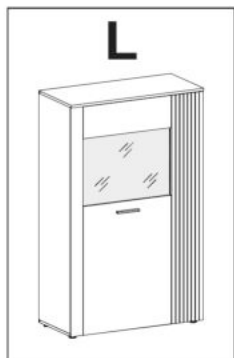
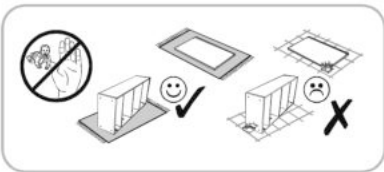

# 16

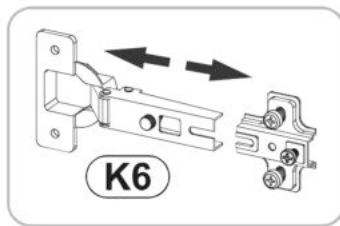
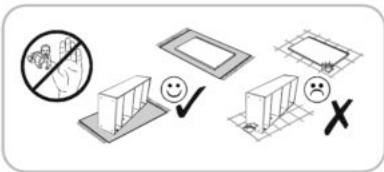

**K6**  
Ø35  x3

**DA21**  
4,2x16  x6

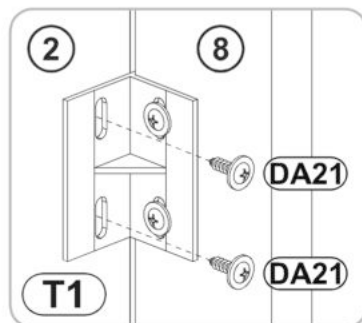
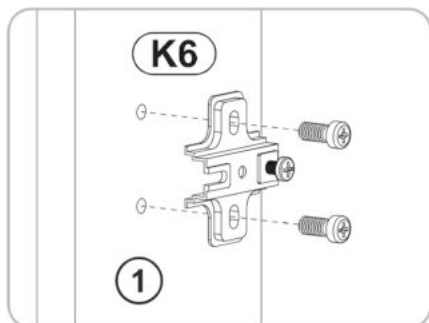
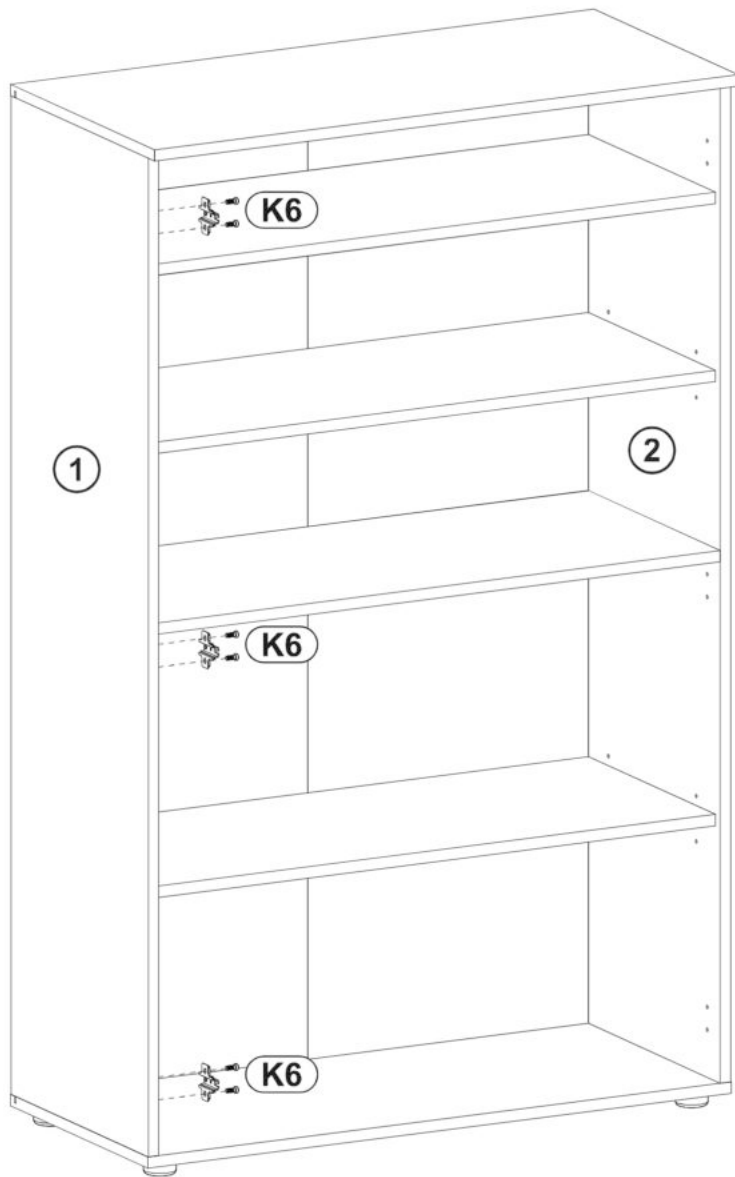

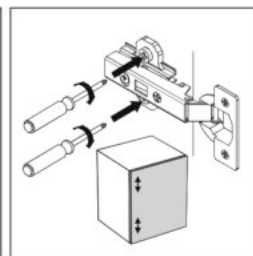
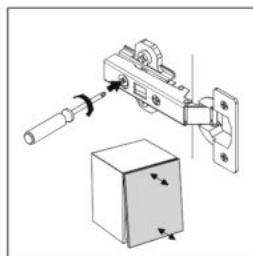
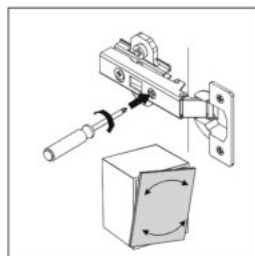
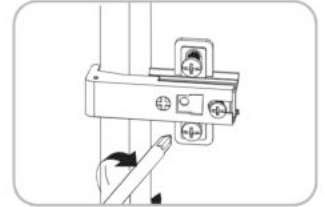
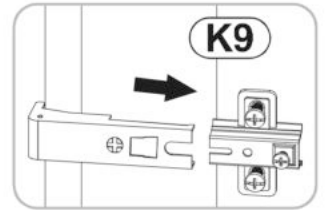
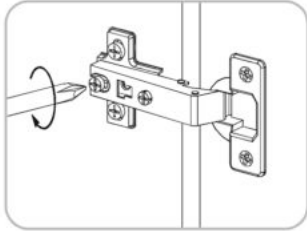
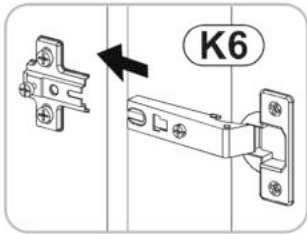
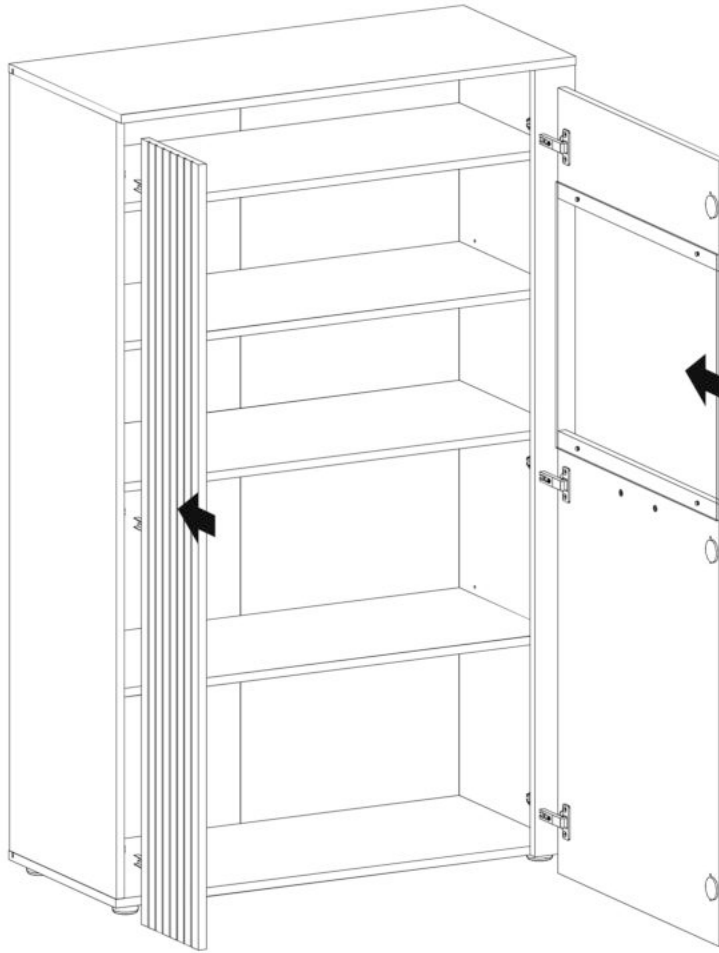
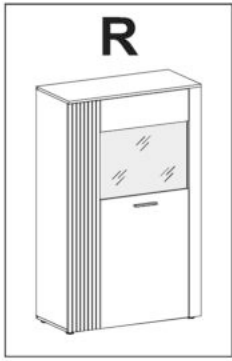
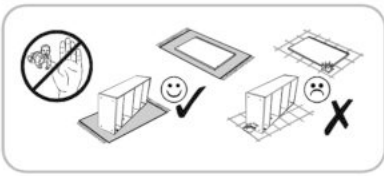



**L**

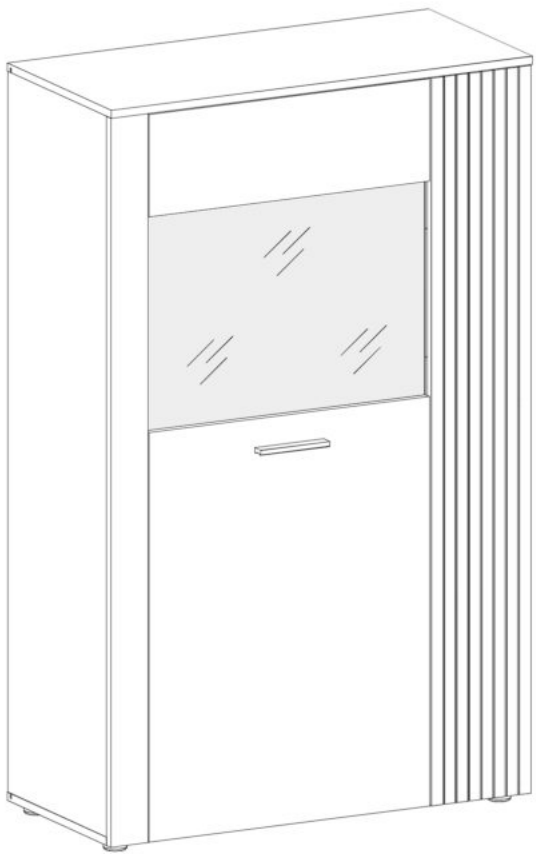

**R**

